

Installation Instructions for mounting HLB Liners/Ventilators in wood range hoods

Rectangular Liners are to be used with Chimney and Mantel style Range Hoods.

- 1) Locate available studs in area where the Range Hood is to be installed.
- 2) Align Range Hood so at least two screws will be secured through range hood mounting strip and into available studs on rear wall.
- 3) Refer to manufacturers guidelines that accompany the stove/cooktop that will be located beneath the wooden range hood.
- 4) Exposed wood edges should be no less than 30" above cooking surface.
- 5) Mount range hood securely to wall using minimum #8 x 2-1/2" long framing screws.
- 6) Remove protective peel coat from liner (if applicable).
- 7) Install ventilation Power Pack securely to Rectangular Shaped Steel Liner as outlined in ventilator instruction packet.. Ventilator cut out to be oriented as shown in diagram below.
- 8) Secure Liner/Ventilator assembly to inside of range hood opening using available mounting holes (a) and secure with wood screws (#6 x 1/2" not included).
- 9) Install duct work or ductless kit to ventilator power pack according to manufacturer's guidelines.
- 10) If Chimney Hood is being installed, attach chimney extension over ductwork and fasten to wall with framing screws, securing to studs where available. If studs are not present in mounting area, use drywall anchors.
- 11) If Mantel Hood is being installed, mount doors or decorative panels as appropriate.

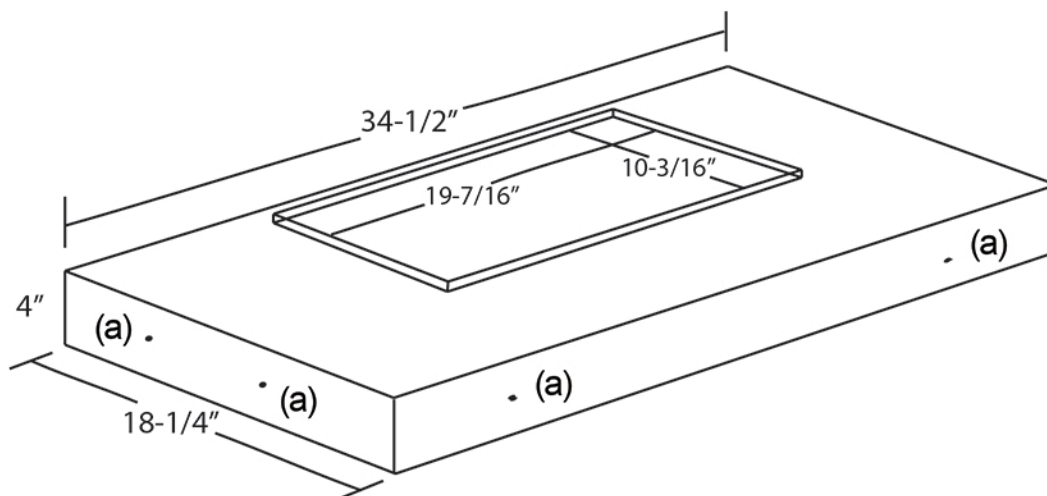

SY-HLB36 Liner